

Varenummer: 2301044421
 Beskrivelse: E+G Håndsving
 MT.130+IR-A14

Mål

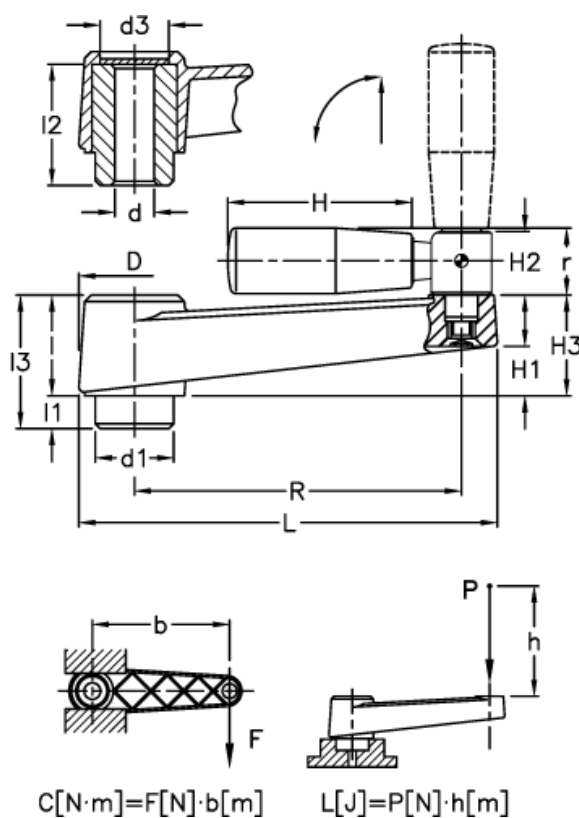

C (N*m) = 350	H3 = 35	R = 130
D = 40	l = 35	
d1 = 28	L = 162	
d3 = 25	L (J) = 45	
d H7 = 14	l1 = 14	
H = 65	l2 = 44	
H1 = 20	l3 = 49	
H2 = 20	r = 22	